

Computer models



for a
cool star



in the vicinity of a
hot subdwarf



Fiona Prodöhl, M.Sc.
Hamburg Observatory

What is so interesting about AADor?

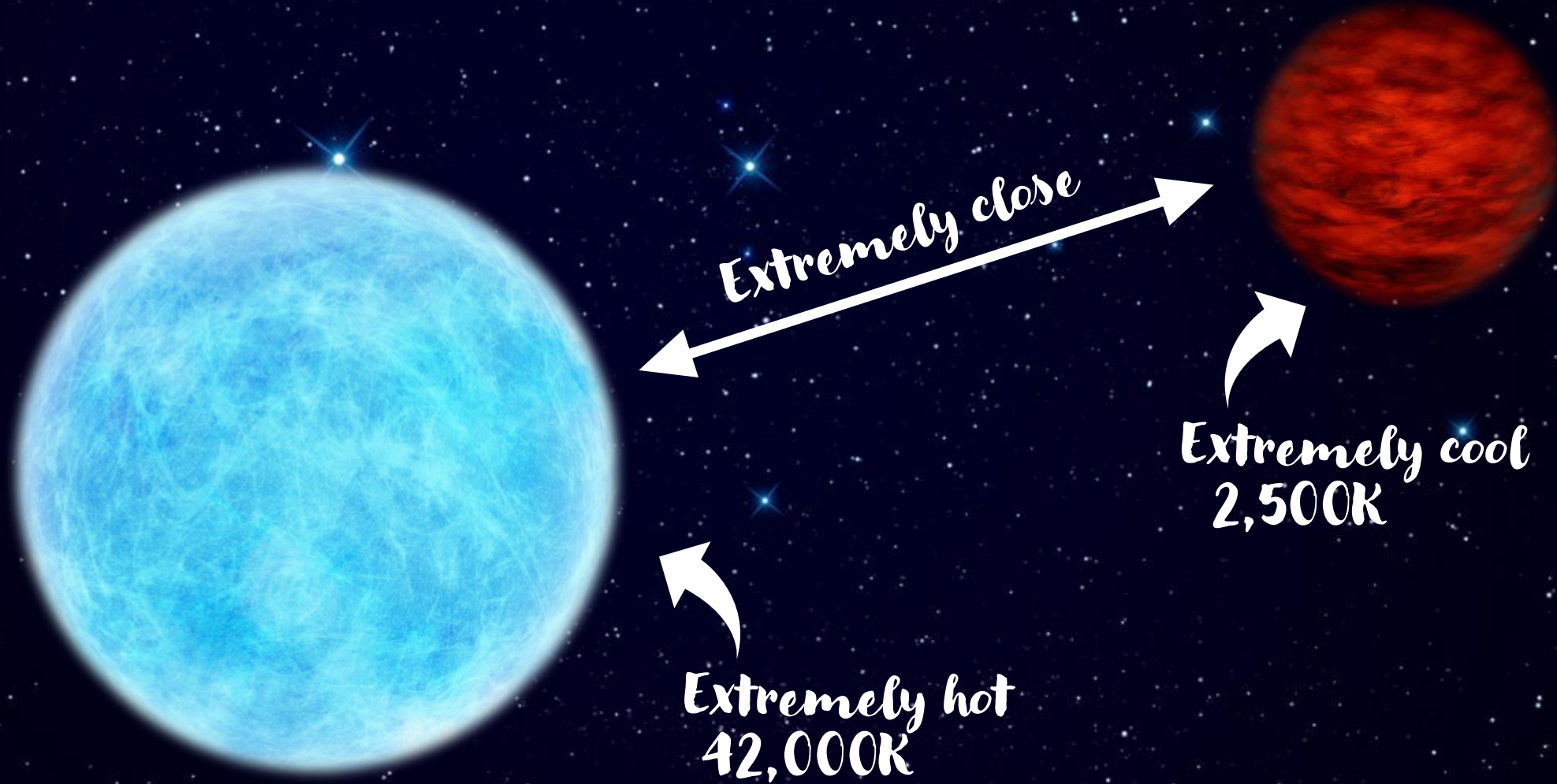

How can a star be 1D?

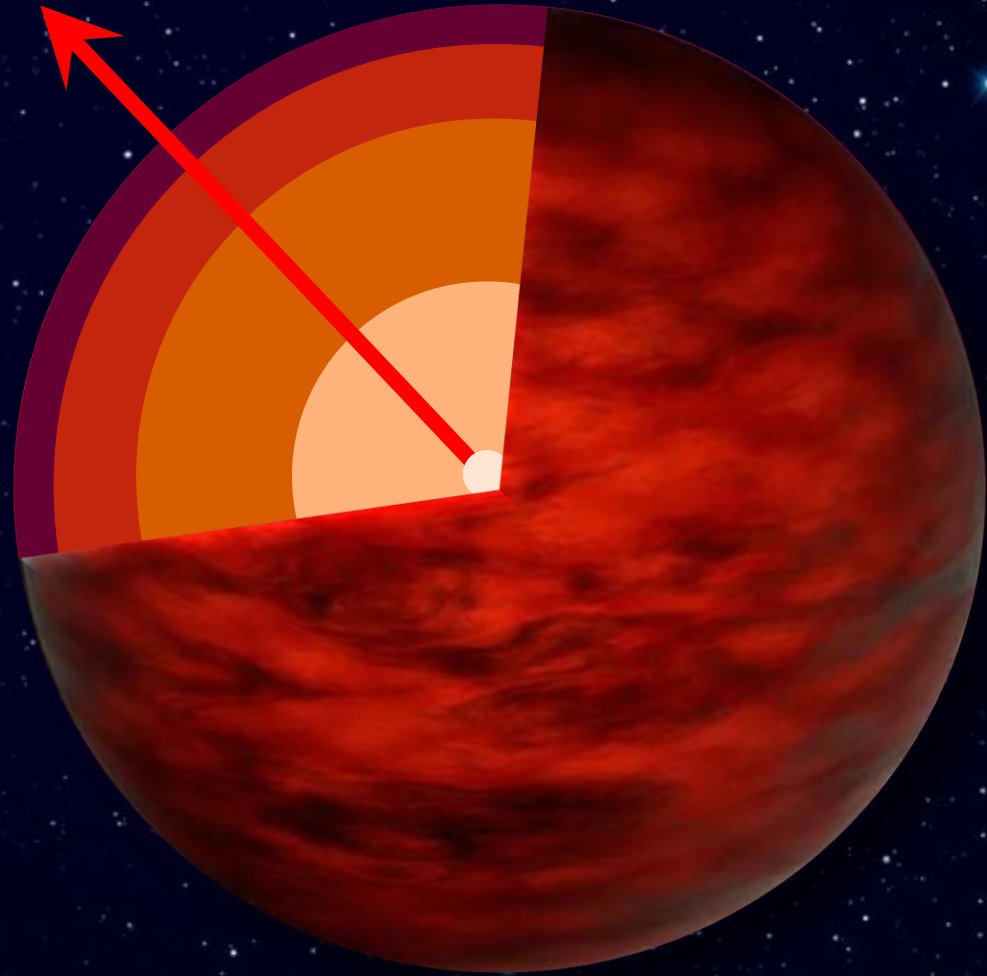

Irradiation!

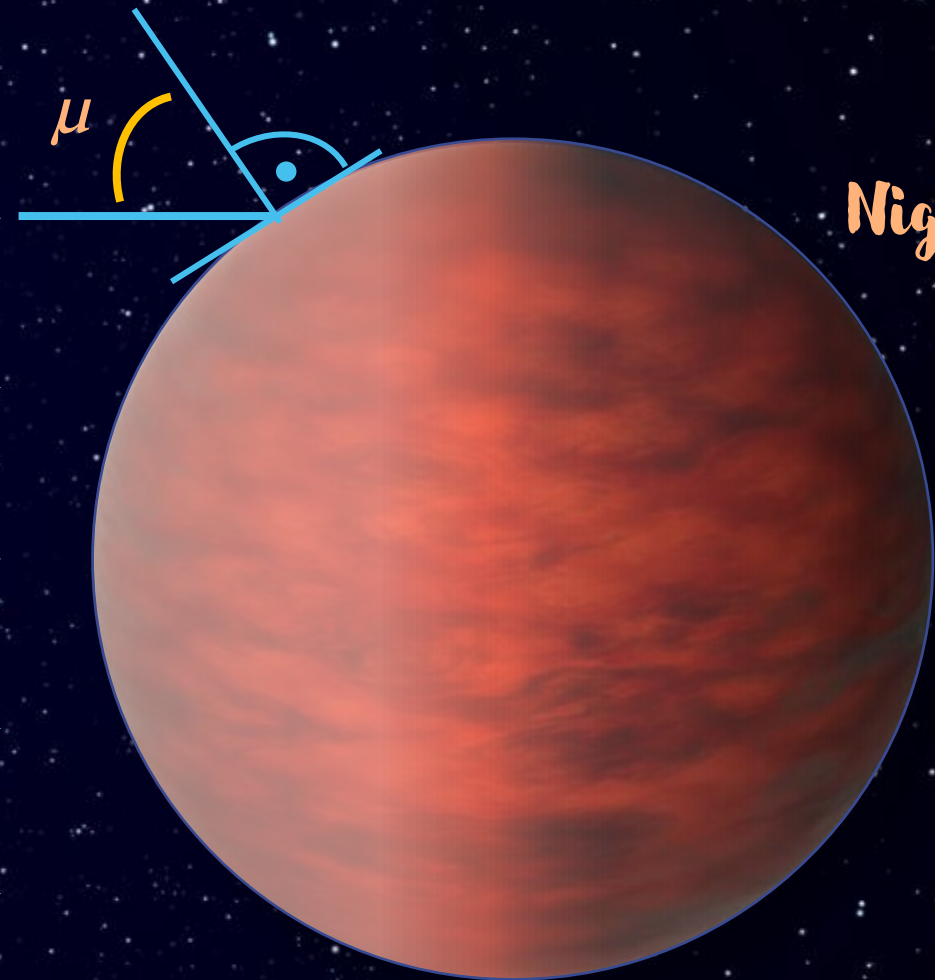
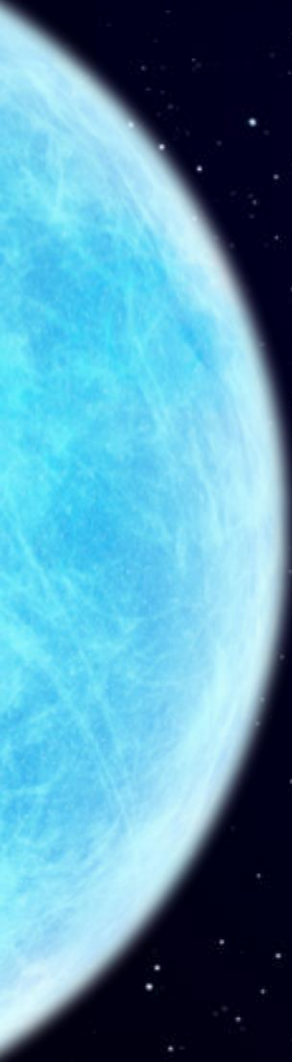

Night side

μ

1.5D Hydrodynamic Structure

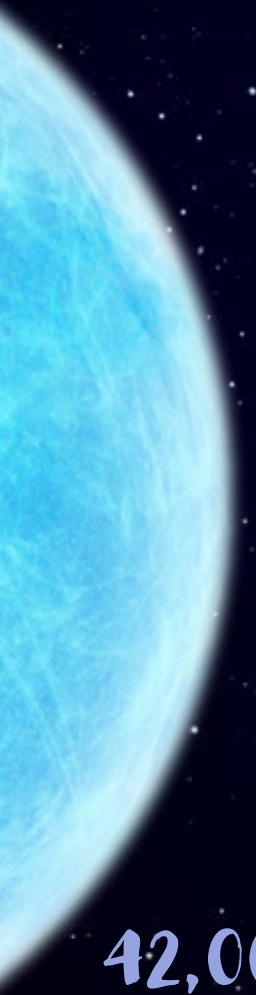

42,000K

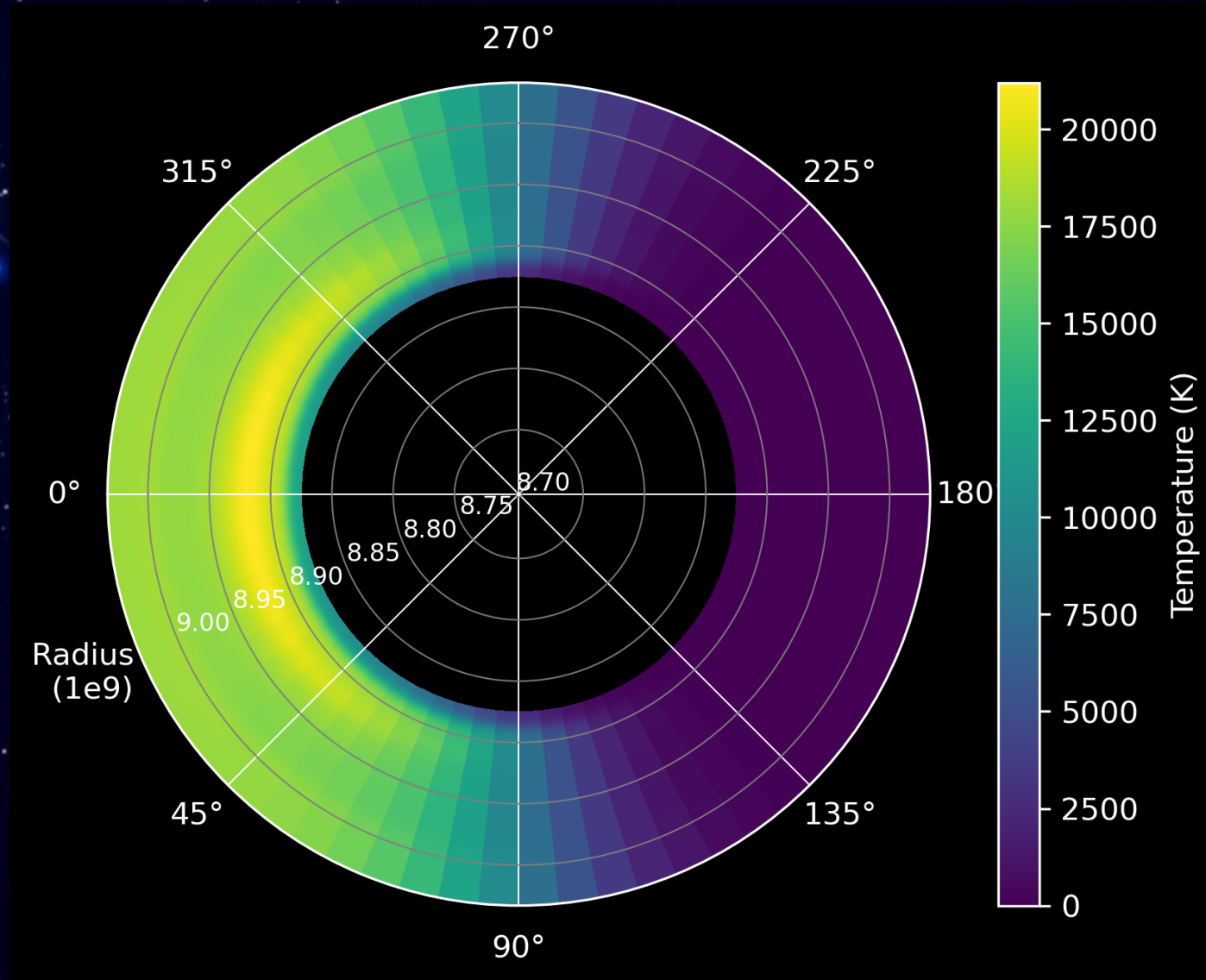

Night side

Atmosphere Expansion

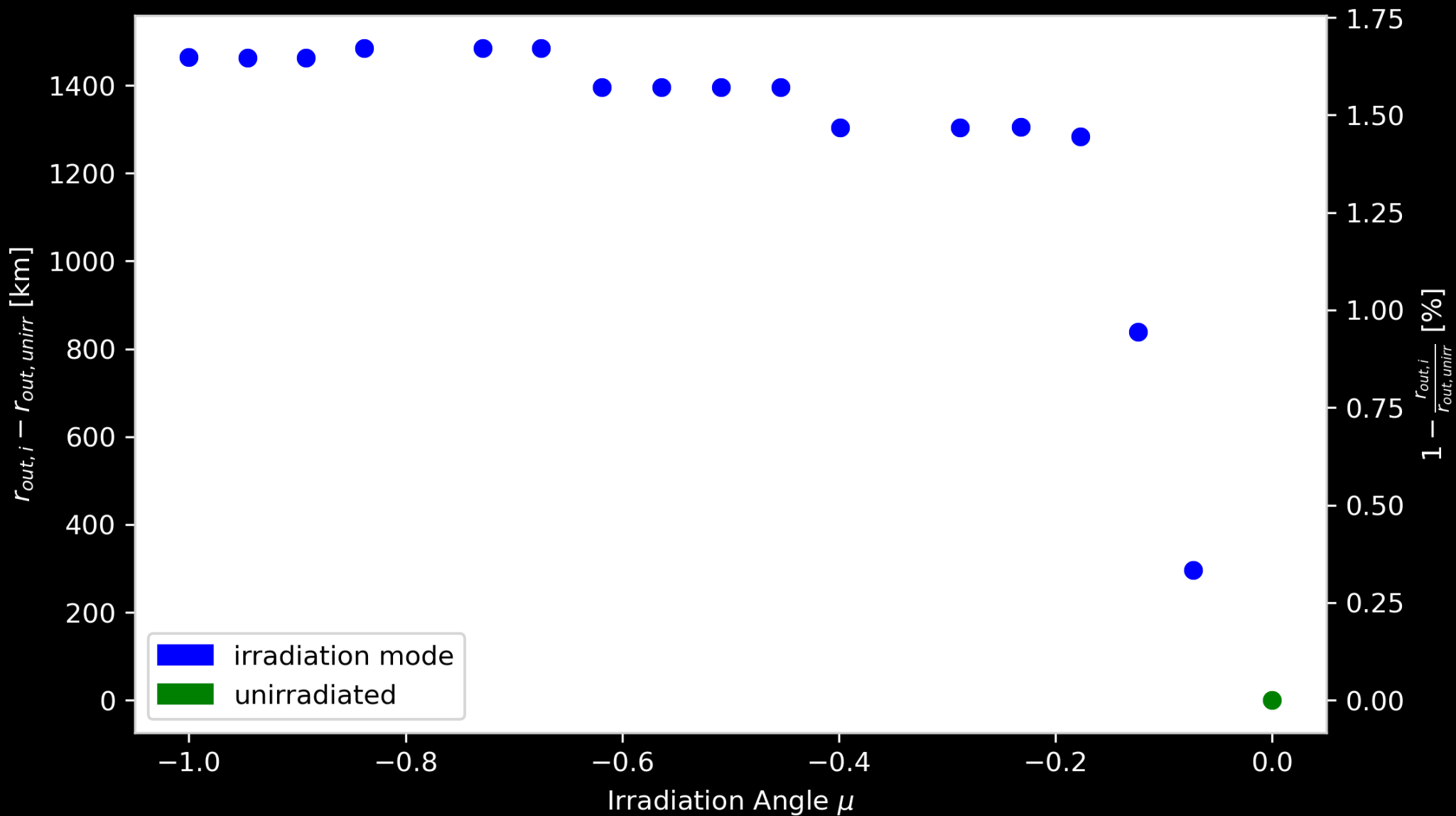

1D Spectra

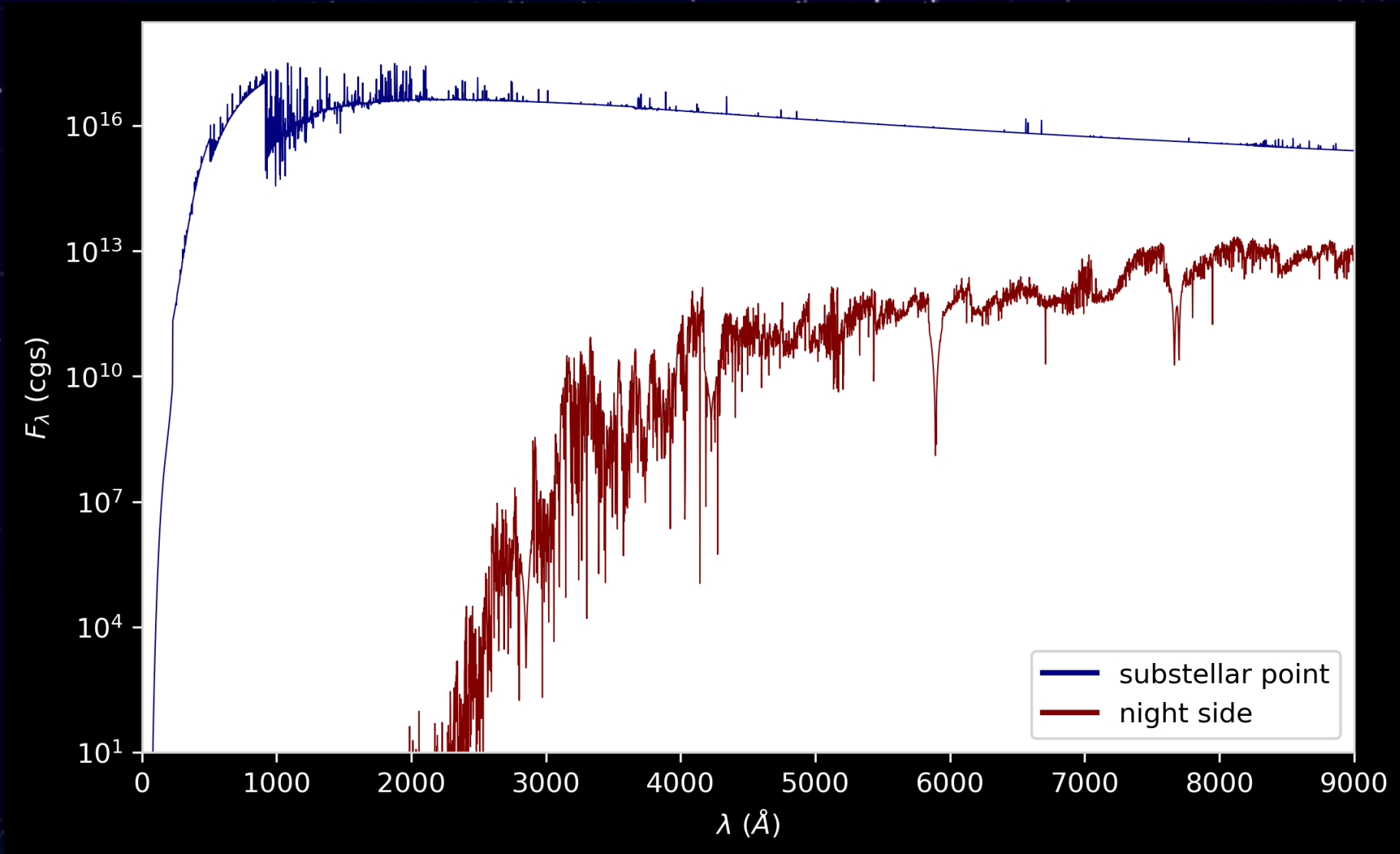

1.5D Spectrum

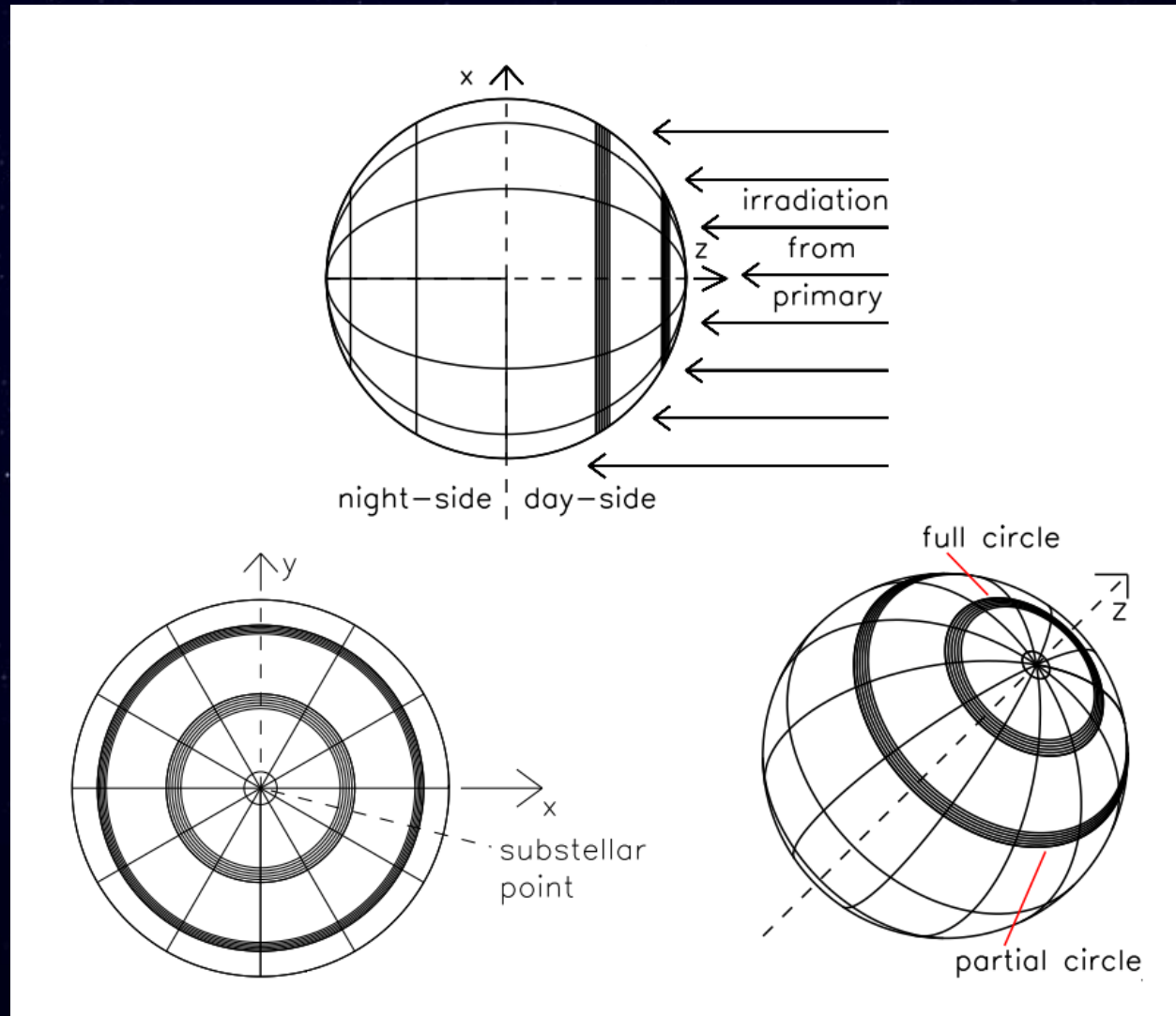

Early 1.5D Spectrum

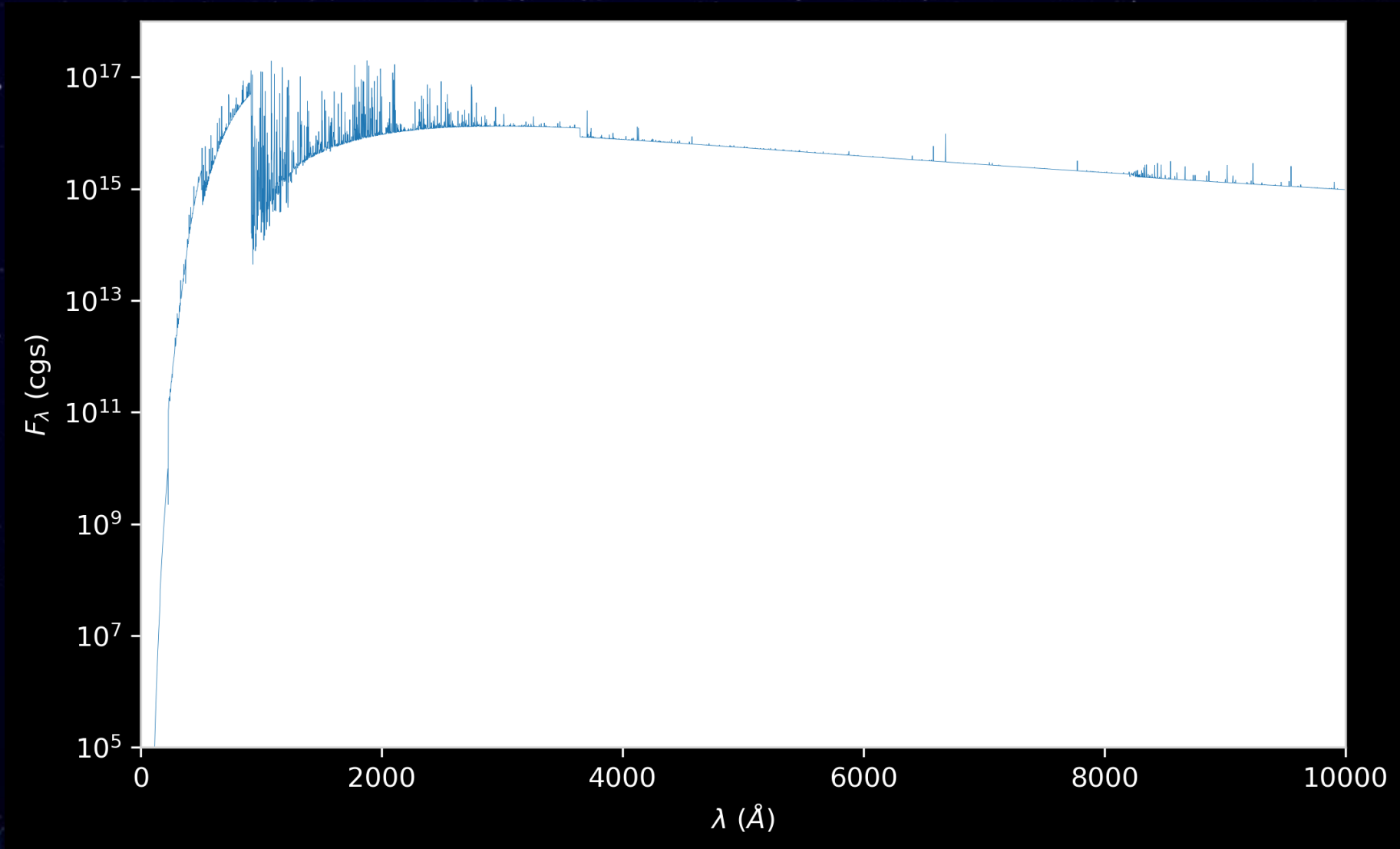

Early 3D Results





Thank you!

Questions?